

UNIQUE

DESIGN FOR PEOPLE

COLLECTION

2019 / 02

SINCE
2007

UNIQUE IS A WELL-KNOWN EUROPEAN MANUFACTURER, IMPORTER AND SELLER OF MODERN OFFICE, HOME AND BAR FURNITURE, COMBINING MODERN DESIGN WITH ERGONOMICS AND FUNCTIONALITY, WHICH CAN SATISFY THE REQUIREMENTS OF EVEN THE MOST DEMANDING CUSTOMERS. RELIABILITY AND CAREFULLY DESIGNED APPEARANCE OF OUR FURNITURE GUARANTEES THE HIGHEST QUALITY LEVEL AT ALL TIMES.

OUR YOUNG, CREATIVE TEAM ARE PASSIONATE ABOUT THEIR WORK. THE ATMOSPHERE HERE IS CONDUCIVE TO ACHIEVING BETTER AND BETTER RESULTS. WE KNOW THE LATEST MARKET TRENDS AND THE NEEDS OF OUR CUSTOMERS, WHICH, COMBINED WITH OUR KNOWLEDGE, SKILLS AND EXPERIENCE, ALLOWS US TO OFFER PRODUCTS OF THE HIGHEST QUALITY. WE ATTACH A GREAT IMPORTANCE TO EVERY DETAIL, BECAUSE IT'S THE DETAILS THAT GIVE FURNITURE UNIQUE FEATURES. WE ALSO CARE GREATLY ABOUT PROFESSIONAL CUSTOMER SERVICE, SAFETY, AND ENVIRONMENTAL PROTECTION.

THE IDEA FOR OUR BUSINESS DATES BACK TO GERMANY IN 2005. WE HAVE BUSINESS AND FAMILY CONNECTIONS WITH THE DITTRICH DESIGN GMBH. OUR COOPERATION BRINGS BENEFITS AND EXPERIENCES TO BOTH PARTIES. TO SEE WHAT WE OFFER, CONTACT US, OUR SALES REPRESENTATIVES OR ANY OF UNIQUE PARTNER FURNITURE STORES. CHOOSING OUR FURNITURE WILL BE A GOOD DECISION.

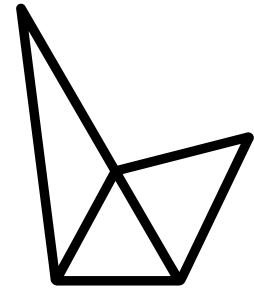

UNIQUE
DESIGN FOR PEOPLE



PRODUCTS

ARMCHAIRS AND OFFICE CHAIRS

ADELLA	40
APOLLO	28
APOLLO M	29
ARES	35
ARES MESH	34
ARES SOFT	33
AWARD	49
BLACK ON BLACK	50
BLACK ON BLACK PLUS	51
BLOSSOM	39
BRANDO	41
BRAVA	54
BRAVO	55
CELIO	38
ERGONIC	20
ERGOTECH	13-15
ERGOTHRONE	16-17
ESTA	21
EXPANDER	25
EXPLORE	27
FORTE	32
FOX	52
FULKRUM	31
HERO	10-11
MILLO	53
MOBI	46
MOBI PLUS	47
NEZ	24
OVERCROSS	48
REGENT	42
REGENT LOW	43
ROVER 2	57

SAIL	37
SHELL	12
SPINELLY	6
SPINELLY M	7
TASK	26
THUNDER	45
TUNE	18
VELO	30
VIP	23
VIPER	44
VISITOR	56
VISTA	19
WAU	8
WAU 2	9
WORK	22
WYE	36

KIDS CHAIRS

ROOKEE	60
ELI	61
JIMMY	62
TOMMY	63

SPECIALISED CHAIRS

KADEN	66
SITOOOL	67

DESKS, WARDROBES, SHELVES

AMY	86
BISE	83
BORA	84
CLEO	87
DD Z-LINE	72

DD Z-LINE DIALOG	75
DELLA	88
DORIS	89
EDNA	90
GRACE	91
CONTAINER 324/325	94
CONTAINER 424	95
CONTAINER JSGW-010	96
CONTAINER RP-01 / RP-04	92
CONTAINER RPH-01 / RPH-02	93
MARIN	79
PISA	78
SECA	82
SOLANO	85
CONFERENCE TABLE	
Z-LINE / DD Z-LINE	76
TIVANO	80
Z-LINE / DD Z-LINE CORNER	73
Z-LINE	71
Z-LINE DIALOG	74
ZEFIR	81

TABLES AND CHAIRS

AREA	109
CITY	102
DESIGN	108
EASY	106
EASY R	107
HELENA	114
LINE	101
LUMI	110
LUNA	115
MALMO	119
MONTANA	118

MUZE	100
OPEN	111
SETINA	105
SOFT	112
STILO	103
SULTAN	104
TALIA	113
TEXAS PMG	117
TEXAS RDG	116

HOKERS AND BAR TABLES

CARINO	123
CLUB / SPOONY	124
DUKE	122
ROUND / BISTRO	125

GAMING CHAIRS AND DESKS

DYNAMIQ V2	134
DYNAMIQ V3	128
DYNAMIQ V4	135
DYNAMIQ V5	129
DYNAMIQ V6	136
DYNAMIQ V7	130
DYNAMIQ V8	137
DYNAMIQ V9	131
DYNAMIQ V11	132
DYNAMIQ V13	133

ACCESSORIES	140
PATTERNS OF FINISHES	144
NEWS	149



ARMCHAIRS AND OFFICE CHAIRS

SPINELLY

HEADREST AND BACKREST UPHOLSTERED WITH ELASTIC MESH
SEAT UPHOLSTERED WITH FABRIC OR NATURAL LEATHER

SELF-WEIGHING SYNCHRON MECHANISM
MADE OF POLISHED ALUMINIUM



AVAILABLE UPHOLSTERY:
SEAT: FABRIC BL (18 COLOURS) , NATURAL LEATHER HL (3 COLOURS)
BACKREST AND HEADREST: MESH LN (1 COLOUR)

- ADJUSTMENTS:
- HEIGHT AND DEPTH OF SEAT
 - HEIGHT OF ARMRESTS
 - HEIGHT OF THE LUMBAR SUPPORT

SPINELLY M



AVAILABLE OPTIONS:
POSSIBILITY OF CHANGING THE BASE TO: LACQUERED ALUMINIUM 0009

W A U

UPHOLSTERY OF FABRIC, NET OR ELASTOMER
SLID DEVIATION MECHANISM
BASE MADE OF LACQUERED ALUMINIUM

ADJUSTMENTS: • BACKREST HEIGHT
• HEIGHT OF HEADREST
• HEIGHT AND SWING OF THE ARMRESTS



AVAILABLE UPHOLSTERY:
FABRIC BL (18 COLOURS); NW MESH (6 COLOURS); TPE (2 COLOURS)



WAU ARMCHAIR IN A VERSION WITH A WIDER BACKREST

W A U 2



AVAILABLE UPHOLSTERY:
FABRIC BL (18 COLOURS); NW MESH (6 COLOURS); TPE (2 COLOURS)



HERO

BACKREST AND HEADREST UPHOLSTERED WITH MESH
SEAT UPHOLSTERED WITH NET OR FABRIC
SEAT, BACKREST AND HEADREST UPHOLSTERED WITH FABRIC

SELF-WEIGHING SYNCHRON MECHANISM
BASE MADE OF POLISHED ALUMINIUM



AVAILABLE UPHOLSTERY:
NWH MESH (2 COLOURS); BLH FABRIC (2 COLOURS); SM FABRIC (7 COLOURS)

ADJUSTMENTS:

- HEIGHT AND DEPTH OF SEAT
- ARMRESTS IN 4 PLANES

- HEIGHT AND INCLINATION ANGLE OF THE HEAD RESTRAINT
- HEIGHT OF THE LUMBAR SUPPORT

HERO



SHELL

SEAT, BACKREST AND HEADREST UPHOLSTERED WITH FABRIC
SYNCHRON SWING MECHANISM
HIGH QUALITY BASE

ADJUSTMENTS:

- SEAT HEIGHT
- SEAT DEPTH
- HEIGHT OF ARMRESTS
- HEIGHT OF HEADREST



AVAILABLE UPHOLSTERY:
BACKREST AND SEAT: BL418 FABRIC

SEAT, BACKREST AND HEADREST COVERED WITH MESH
SELF-WEIGHING SYNCHRON MECHANISM
POLISHED ALUMINIUM BASE

ADJUSTMENTS:

- SEAT HEIGHT
- SEAT DEPTH
- 3D ARMRESTS
- HEIGHT OF HEADREST
- BACKREST HEIGHT

ERGOTECH



AVAILABLE UPHOLSTERY:
MESH



ERGOTECH

SEAT, BACKREST AND HEADREST COVERED WITH MESH
SELF-WEIGHING SYNCHRON MECHANISM
HIGH QUALITY BASE

ADJUSTMENTS:

- SEAT HEIGHT
- SEAT DEPTH
- 3D ARMRESTS

- HEIGHT OF HEADREST
- BACKREST HEIGHT



SEAT, BACKREST AND HEADREST COVERED WITH MESH
SELF-WEIGHING SYNCHRON MECHANISM
HIGH QUALITY BASE

ADJUSTMENTS:

- SEAT HEIGHT
- SEAT DEPTH
- 3D ARMRESTS
- HEIGHT OF HEADREST
- BACKREST HEIGHT

ERGOTECH



AVAILABLE UPHOLSTERY:
MESH



ERGO THRONE

SEAT, BACKREST AND HEADREST COVERED WITH MESH
SELF-WEIGHING SYNCHRON MECHANISM
POLISHED ALUMINIUM BASE

ADJUSTMENTS:

- SEAT HEIGHT
- SEAT DEPTH
- HEIGHT OF HEADREST
- BACKREST HEIGHT
- DEPTH OF THE LUMBAR SUPPORT



AVAILABLE OPTIONS:
ARMCHAIR COULD BE EQUIPPED WITH A COMFORTABLE FOOTREST



AVAILABLE UPHOLSTERY:
MESH



SEAT, BACKREST AND HEADREST COVERED WITH MESH
SELF-WEIGHING SYNCHRON MECHANISM
ALUMINIUM BASE

ADJUSTMENTS:
• SEAT HEIGHT
• SEAT DEPTH
• HEIGHT OF HEADREST

- BACKREST HEIGHT
- DEPTH OF THE LUMBAR SUPPORT

ERGO THRONE



AVAILABLE UPHOLSTERY:
MESH



AVAILABLE OPTIONS:
ARMCHAIR COULD BE EQUIPPED WITH A COMFORTABLE FOOTREST



TUNE

SEAT AND HEADREST UPHOLSTERED WITH FABRIC
BACKREST COVERED WITH MESH
SYNCHRON SWING MECHANISM
HIGH QUALITY BASE

ADJUSTMENTS:

- SEAT HEIGHT
- SEAT DEPTH
- BACKREST HEIGHT
- 3D ARMRESTS
- DEPTH OF THE LUMBAR SUPPORT
- HEIGHT AND INCLINATION ANGLE OF THE HEAD RESTRAINT



AVAILABLE OPTIONS:
POSSIBILITY OF CHANGING THE BASE TO:
ALUMINIUM 0009



AVAILABLE UPHOLSTERY:
SEAT AND HEADREST: FABRIC BL418 (18 COLOURS), NATURAL LEATHER HL (3 COLOURS)
BACKREST: MESH-C NET (8 COLOURS)

HEADREST AND BACKREST UPHOLSTERED WITH MESH
SEAT UPHOLSTERED WITH FABRIC
SYNCHRON SWING MECHANISM
POLISHED ALUMINIUM BASE

ADJUSTMENTS:
• SEAT HEIGHT
• 3D ARMRESTS
• HEIGHT AND INCLINATION ANGLE OF THE HEAD RESTRAINT

VISTA



AVAILABLE UPHOLSTERY:
HEADREST AND BACKREST : NWM-4 MESH
SEAT : FABRIC BL418



ERGONIC

HEADREST AND BACKREST UPHOLSTERED WITH MESH
SEAT UPHOLSTERED WITH FABRIC
SYNCHRON SWING MECHANISM
HIGH QUALITY BASE

ADJUSTMENTS:

- SEAT HEIGHT
- HEIGHT OF ARMRESTS
- HEIGHT AND INCLINATION ANGLE OF THE HEAD RESTRAINT
- HEIGHT OF THE LUMBAR SUPPORT



AVAILABLE UPHOLSTERY:
HEADREST AND BACKREST : MESH M-31
SEAT : FABRIC BL418

HEADREST AND BACKREST UPHOLSTERED WITH MESH
SEAT UPHOLSTERED WITH FABRIC
SYNCHRON SWING MECHANISM
HIGH QUALITY BASE

ADJUSTMENTS:
HEIGHT OF SEAT, ARMREST AND HEADREST

ESTA



AVAILABLE UPHOLSTERY:
HEADREST AND BACKREST : MESH M-31
SEAT : FABRIC BL418



WORK

BACKREST AND SEAT UPHOLSTERED WITH FABRIC
SYNCHRON SWING MECHANISM
HIGH QUALITY BASE

ADJUSTMENTS:
• SEAT HEIGHT
• HEIGHT OF ARMRESTS



SEAT UPHOLSTERED WITH MEMBRANE FABRIC
BACKREST AND HEADREST COVERED WITH MESH
SYNCHRON SWING MECHANISM
POLISHED ALUMINIUM BASE

- ADJUSTMENTS:
- SEAT HEIGHT
 - HEIGHT AND WIDTH OF ARMRESTS
 - HEIGHT AND DEPTH OF THE LUMBAR SUPPORT
 - HEIGHT AND INCLINATION ANGLE OF THE HEAD RESTRAINT

VIP



AVAILABLE UPHOLSTERY:
SEAT: MEMBRANE PS (8 COLOURS)
BACKREST AND HEADREST: MESH-C NET(8 COLOURS)



NEZ

SEAT UPHOLSTERED WITH FABRIC
BACKREST AND HEADREST COVERED WITH MESH
MULTIBLOCK SWING MECHANISM
HIGH QUALITY BASE

ADJUSTMENTS:
• HEIGHT OF SEAT, HEAD RESTRAINT
• 3D ARMRESTS



AVAILABLE UPHOLSTERY:
SEAT: FABRIC BL (18 COLOURS)
BACKREST AND HEADREST: MESH-M NET(6 COLOURS)

SEAT UPHOLSTERED WITH MEMBRANE FABRIC
BACKREST AND HEADREST COVERED WITH MESH
SYNCHRON SWING MECHANISM
POLISHED ALUMINIUM BASE

ADJUSTMENTS:

- SEAT HEIGHT
- HEIGHT AND WIDTH OF ARMRESTS
- HEIGHT OF THE LUMBAR SUPPORT
- HEIGHT AND INCLINATION ANGLE OF THE HEAD RESTRAINT

EXPANDER



AVAILABLE UPHOLSTERY:
SEAT: MEMBRANE PS (8 COLOURS)
BACKREST AND HEADREST: MESH-C NET(8 COLOURS)



TASK

SEAT UPHOLSTERED WITH FABRIC
BACKREST AND HEADREST COVERED WITH MESH
SYNCHRON SWING MECHANISM
HIGH QUALITY BASE

- ADJUSTMENTS:
- SEAT HEIGHT
 - BACKREST HEIGHT
 - HEIGHT OF ARMRESTS
 - HEIGHT OF THE LUMBAR SUPPORT
 - HEIGHT OF THE HEAD RESTRAINT



AVAILABLE UPHOLSTERY:
SEAT: FABRIC BL418
BACKREST: MESH NET

SEAT UPHOLSTERED WITH FABRIC
BACKREST AND HEADREST COVERED WITH MESH
TILT SWING MECHANISM
HIGH QUALITY BASE

ADJUSTMENTS: • SEAT HEIGHT
• HEIGHT OF ARMRESTS
• HEIGHT OF THE HEAD RESTRAINT

EXPLORE



AVAILABLE UPHOLSTERY:
SEAT: FABRIC BL418
BACKREST AND HEADREST : MESH-M NET



APOLLO

BACK, SEAT AND HEADREST UPHOLSTERED WITH FABRIC
MULTIBLOCK SWING MECHANISM

BASE MADE OF LACQUERED ALUMINIUM
SEAT HEIGHT ADJUSTMENT



AVAILABLE OPTIONS:
POSSIBILITY OF CHANGING THE BASE TO: ALUMINIUM 0009



AVAILABLE UPHOLSTERY:
FABRIC BL (18 COLOURS)



APOLLO CHAIR WITH LOW BACKREST

APOLLO M



AVAILABLE UPHOLSTERY:
FABRIC BL (18 COLOURS)



AVAILABLE OPTIONS:
POSSIBILITY OF CHANGING THE BASE TO: ALUMINIUM 0009



VELO

SEAT AND HEADREST UPHOLSTERED WITH FABRIC
BACKREST COVERED WITH MESH
SYNCHRON SWING MECHANISM
POLISHED ALUMINIUM BASE

ADJUSTMENTS: • SEAT HEIGHT
• SEAT DEPTH
• 3D ARMRESTS



AVAILABLE UPHOLSTERY:
SEAT AND HEADREST: FABRIC BL (18 COLOURS)
BACKREST: MESH-M NET

BACKREST COVERED WITH MESH
SEAT, HEADREST AND ARMRESTS UPHOLSTERED WITH FABRIC
SYNCHRON SWING MECHANISM

- ADJUSTMENTS:
- SEAT HEIGHT
 - DEPTH OF THE LUMBAR SUPPORT
 - HEIGHT OF THE HEAD RESTRAINT
 - ARMRESTS: FRONT TO BACK AND SIDEWAYS PIVOT

FULKRUM



AVAILABLE UPHOLSTERY:

BACKREST: MESH M-31

HEADREST, ARMREST PADS, SEAT: BL FABRIC (18 COLOURS) OR LEATHER HL-4



FORTE

BACKREST AND HEADREST FINISHED WITH MESH
SEAT UPHOLSTERED WITH FABRIC
SELF-WEIGHING SYNCHRON MECHANISM
POLISHED ALUMINIUM BASE

ADJUSTMENTS: • HEIGHT AND DEPTH OF SEAT, HEIGHT OF HEAD RESTRAINT
• 3D ARMRESTS
• LUMBAR SUPPORT



AVAILABLE OPTIONS:
POSSIBILITY OF CHANGING THE BASE TO: ALUMINIUM LACQUERED 0009



AVAILABLE UPHOLSTERY:
SEAT: FABRIC BL (18 COLOURS), NATURAL LEATHER (3 COLORS)
BACKREST AND HEADREST: MESH-AK-61 NET

SEAT AND HEADREST UPHOLSTERED WITH ECO-LEATHER OR NATURAL LEATHER
BACKREST COVERED WITH MESH
SYNCHRON SWING MECHANISM
HIGH QUALITY BASE

ADJUSTMENTS:
• SEAT HEIGHT
• HEIGHT OF ARMRESTS

ARES SOFT



AVAILABLE UPHOLSTERY:
BACKREST (LEATHER + MESH M-31): NATURAL LEATHER HL-4, ECO LEATHER PU-4 OR PU-1
SEAT: NATURAL LEATHER HL-4, ECO LEATHER PU-4 OR PU-1

AVAILABLE OPTIONS:
POSSIBILITY OF CHANGING THE BASE TO: ALUMINIUM 0009



ARES MESH

SEAT AND HEADREST UPHOLSTERED WITH FABRIC
BACKREST COVERED WITH MESH
SYNCHRON SWING MECHANISM
HIGH QUALITY BASE

ADJUSTMENTS:

- SEAT HEIGHT
- HEIGHT OF ARMRESTS



AVAILABLE OPTIONS:

POSSIBILITY OF CHANGING THE BASE TO: ALUMINIUM 0009



AVAILABLE UPHOLSTERY:

BACKREST (FABRIC + MESH M-31): BL FABRIC (18 COLOURS)
SEAT: BL FABRIC (18 COLOURS)



ECO OR NATURAL LEATHER UPHOLSTERY
SYNCHRON SWING MECHANISM

POLISHED ALUMINIUM BASE
SEAT HEIGHT ADJUSTMENT

A R E S



AVAILABLE UPHOLSTERY:
NATURAL LEATHER: HL-4, HL-1 OR ECO-PU-4 LEATHER

AVAILABLE OPTIONS:
POSSIBILITY OF CHANGING THE BASE TO: ALUMINIUM LACQUERED 0009



W Y E

ECO OR NATURAL LEATHER UPHOLSTERY
TILT PLUS SWING MECHANISM
BACKREST FRAME, ARMRESTS AND BASE MADE OF POLISHED ALUMINIUM

SEAT HEIGHT ADJUSTMENT
STATIONARY CHAIRS HAVE A SKID
MADE OF CHROME PLATED METAL



AVAILABLE UPHOLSTERY:
WYE/WYE LOW : NATURAL LEATHER HL-4 AND HL-1, ECO LEATHER PU-4
WYE SKID: ECO LEATHER PU-4, NATURAL LEATHER HL-4 AND HL-1

ECO OR NATURAL LEATHER UPHOLSTERY
SYNCHRON SWING MECHANISM
POLISHED ALUMINIUM BASE

ADJUSTMENTS:

- SEAT HEIGHT
- HEIGHT AND PIVOT OF THE ARMRESTS

SAIL



AVAILABLE UPHOLSTERY:
HL-4 OR ECO-LEATHER PU-4

AVAILABLE OPTIONS:
POSSIBILITY OF CHANGING THE BASE TO:
ALUMINIUM LACQUERED 0009



CELIO

ECO OR NATURAL LEATHER UPHOLSTERY
TILT PLUS SWING MECHANISM

POLISHED ALUMINIUM BASE
SEAT HEIGHT ADJUSTMENT



ECO OR NATURAL LEATHER UPHOLSTERY
SYNCHRON SWING MECHANISM
SEAT HEIGHT ADJUSTMENT

POLISHED ALUMINIUM BASE
STATIONARY CHAIRS HAVE A SKIDS MADE
OF CHROMIUM-PLATED METAL

BLOSSOM



AVAILABLE UPHOLSTERY:
BLOSSOM: NATURAL LEATHER HL-4 OR ECO-LEATHER PU-4
BLOSSOM SKID: ECO LEATHER PU-4

AVAILABLE OPTIONS:
BLOSSOM: CHANGEABLE FROM BASE TO ALUMINIUM LACQUERED 0009



ADELLA

ECO OR NATURAL LEATHER UPHOLSTERY
SYNCHRON SWING MECHANISM
SEAT HEIGHT ADJUSTMENT

POLISHED ALUMINIUM BASE
STATIONARY CHAIRS HAVE A SKID MADE OF
CHROME-PLATED METAL



AVAILABLE UPHOLSTERY:
ADELLA: NATURAL LEATHER HL-4 OR ECO LEATHER PU-4
ADELLA SKID: EKO LEATHER PU-4

ECO OR NATURAL LEATHER UPHOLSTERY
TILT PLUS SWING MECHANISM
SEAT HEIGHT ADJUSTMENT

POLISHED ALUMINIUM BASE
STATIONARY CHAIRS HAVE A SKID MADE
OF CHROME-PLATED METAL

BRANDO



AVAILABLE UPHOLSTERY:
BRANDO: NATURAL LEATHER HL-4 OR ECO LEATHER PU-4
BRANDO SKID: EKO LEATHER PU-4



REGENT

BACKREST AND SEAT UPHOLSTERED WITH NATURAL LEATHER
SELF-WEIGHING SYNCHRON MECHANISM

CHROME-PLATED ALUMINIUM BASE
ARMREST PADS MADE OF SOLID WOOD

ADJUSTMENTS:
• SEAT HEIGHT
• HEIGHT OF HEAD RESTRAINT



BACKREST AND SEAT UPHOLSTERED WITH NATURAL LEATHER
SELF-WEIGHING SYNCHRON MECHANISM

CHROME-PLATED ALUMINIUM BASE
ARMREST PADS MADE OF SOLID WOOD

ADJUSTMENTS:
• SEAT HEIGHT

REGENT LOW



AVAILABLE UPHOLSTERY:
NATURAL LEATHER



VIPER

SEAT UPHOLSTERED WITH MEMBRANE FABRIC AND ECO LEATHER
BACKREST COVERED WITH MESH, HEADREST MADE OF ECO LEATHER

TILT SWING MECHANISM
CHROME-PLATED METAL BASE



AVAILABLE UPHOLSTERY:
SEAT: MEMBRANE PS (8 COLOURS)
BACKREST: MESH-C NET (8 COLOURS)

SEAT UPHOLSTERED WITH MEMBRANE FABRIC
BACKREST COVERED IN MESH WITH ECO-LEATHER INSERTS

TILT SWING MECHANISM
CHROME-PLATED METAL BASE

THUNDER



AVAILABLE UPHOLSTERY:
SEAT: MEMBRANE PS (8 COLOURS)
BACKREST: MESH-C NET (8 COLOURS)



MOBI

SEAT UPHOLSTERED WITH MEMBRANE FABRIC
BACKREST COVERED WITH MESH

TILT SWING MECHANISM
CHROME-PLATED METAL BASE



AVAILABLE OPTIONS:
POSSIBILITY OF CHANGING ARMRESTS TO ADJUSTABLE AD-18



AVAILABLE UPHOLSTERY:
SEAT: MEMBRANE PS (8 COLOURS)
BACKREST: MESH-C NET (8 COLOURS)

MOBI CHAIR WITH HIGHER BACKREST VERSION

MOBI PLUS



AVAILABLE UPHOLSTERY:
SEAT: MEMBRANE PS (8 COLOURS)
BACKREST: MESH-C NET (8 COLOURS)



AVAILABLE OPTIONS:
POSSIBILITY OF CHANGING ARMRESTS TO ADJUSTABLE AD-18



OVERCROSS

SEAT AND HEADREST UPHOLSTERED WITH MEMBRANE FABRIC
BACKREST COVERED WITH MESH
CHROME-PLATED METAL BASE

TILT SWING MECHANISM
SEAT HEIGHT ADJUSTMENT



AVAILABLE UPHOLSTERY:
SEAT AND HEADREST: MEMBRANE PS (8 COLOURS)
BACKREST: MESH-C4 NET

SEAT COVERED WITH MEMBRANE FABRIC
MESH BACKREST
TILT SWING MECHANISM

CHROME-PLATED METAL BASE
SEAT HEIGHT ADJUSTMENT

A W A R D



AVAILABLE UPHOLSTERY:
SEAT: MEMBRANE PS (8 COLOURS)
BACKREST: MESH-C NET (8 COLOURS)



BLACK ON BLACK

BACKREST AND UPHOLSTERED SEAT
TILT SWING MECHANISM

CHROME-PLATED METAL BASE
SEAT HEIGHT ADJUSTMENT



AVAILABLE UPHOLSTERY:
FABRIC NL-4, FABRIC LF (6 COLOURS), MEMBRANE PS (7 COLOURS)

BACKREST AND UPHOLSTERED SEAT
TILT SWING MECHANISM
HIGH QUALITY BASE

ADJUSTMENTS:
• HEIGHT OF ARMRESTS
• SEAT HEIGHT

BLACK ON BLACK PLUS



AVAILABLE UPHOLSTERY:
FABRIC LF (6 COLOURS), MEMBRANE PS (7 COLOURS)



AVAILABLE OPTIONS:
POSSIBILITY OF CHANGING THE BASE TO: ALUMINIUM 0009



FOX

SEAT UPHOLSTERED WITH FABRIC
BACKREST COVERED WITH MESH AND FABRIC

TILT SWING MECHANISM
BASE MADE OF LACQUERED METAL



FABRIC UPHOLSTERY
TILT SWING MECHANISM

HIGH QUALITY BASE
SEAT HEIGHT ADJUSTMENT

MILLO



AVAILABLE UPHOLSTERY:
MT FABRIC (5 COLOURS)



B R A V A

UPHOLSTERED SEAT
SWIVEL SEAT WITHOUT HEIGHT ADJUSTMENT
BASE MADE OF LACQUERED METAL



UPHOLSTERED SEAT
TILT SWING MECHANISM

SEAT HEIGHT ADJUSTMENT
BASE MADE OF LACQUERED METAL

BR A V O



AVAILABLE UPHOLSTERY:
MT FABRIC (5 COLOURS)



VISITOR

WIVEL SEAT UPHOLSTERED WITH FABRIC
ARMRESTS MADE OF CHROME-PLATED METAL
CHROME-PLATED METAL BASE



BACKREST MADE OF STRONG PLASTIC
SWIVEL SEAT UPHOLSTERED WITH FABRIC

PLASTIC BASE WITH BASKET
360° SWIVELABLE WORKTOP

ROVER 2



AVAILABLE UPHOLSTERY:
SEAT: FABRIC BL (18 COLOURS)





KIDS CHAIRS

ROOKEE

SEAT AND BACKREST UPHOLSTERED WITH FABRIC
HIGH QUALITY BASE
BASE EQUIPPED WITH A PLASTIC FOOTREST

ADJUSTMENTS:

- SEAT HEIGHT
- SEAT DEPTH
- BACKREST HEIGHT



SEAT AND BACKREST UPHOLSTERED WITH FABRIC
CHROME-PLATED ALUMINIUM BASE

ADJUSTMENTS:
• SEAT HEIGHT

E L I



AVAILABLE UPHOLSTERY:
GRAPHIC



JIMMY

SEAT AND BACKREST UPHOLSTERED WITH FABRIC
CHROME-PLATED ALUMINIUM BASE

ADJUSTMENTS:

- SEAT HEIGHT
- SEAT DEPTH
- BACKREST HEIGHT



SEAT AND BACKREST UPHOLSTERED WITH MEMBRANE FABRIC
CHROME-PLATED ALUMINIUM BASE

ADJUSTMENTS:
• SEAT HEIGHT
• BACKREST TILT FORCE

TOMMY



AVAILABLE UPHOLSTERY:
MEMBRANE PS (4 COLOURS)





SPECIALISED CHAIRS

KADEN

BACKREST MADE OF PP MATERIAL
SWIVEL CHAIR UPHOLSTERED WITH ECO LEATHER
SEAT HEIGHT ADJUSTMENT



A SEAT FOR DYNAMIC WORK
WIDE SWIVEL ANGLE
ADJUSTABLE HEIGHT

SEAT UPHOLSTERED WITH FABRIC
THE BASE IS MADE OF ELASTOMER WHICH ADAPTS TO THE GROUND

SITOO L



AVAILABLE UPHOLSTERY:
FABRIC BL (18 COLOURS)





DESKS, WARDROBES, SHELVES

Z-LINE / DD Z-LINE



CHROME-PLATED METAL CONSTRUCTION
HEIGHT-ADJUSTABLE LEGS
POSSIBILITY OF CONNECTING DESKS WITH A CORNER

Z-LINE



XXL: 180 X 76 X 73



MAIN DESK: 152 X 76 X 73



COMPUTER DESK: 122 X 76 X 73



DESK PLUS: 120 X 60 X 73

AVAILABLE WORKTOPS:
MDF, PLYWOOD, GLASS



DD Z-LINE

CONSTRUCTION OF LACQUERED METAL
HEIGHT-ADJUSTABLE LEGS
POSSIBILITY OF CONNECTING DESKS WITH A CORNER



XXL: 180 X 76 X 73



MAIN DESK: 152 X 76 X 73



COMPUTER DESK: 122 X 76 X 73



DESK PLUS: 120 X 60 X 73



CONNECTING ELEMENT BETWEEN DESKS FROM THE Z-LINE
AND DD Z-LINE SERIES
CHROME-PLATED OR VARNISHED METAL CONSTRUCTION

Z-LINE / DD Z-LINE CORNER



AVAILABLE WORKTOPS:
MDF, PLYWOOD, GLASS



Z - LINE DIALOG

CHROME-PLATED METAL CONSTRUCTION
HEIGHT-ADJUSTABLE LEGS
POSSIBILITY OF CONNECTING SHELVES SEGMENTS



68 X 36 X 195



CONSTRUCTION MADE OF LACQUERED METAL
HEIGHT-ADJUSTABLE LEGS
POSSIBILITY OF CONNECTING SHELVES SEGMENTS

DD Z-LINE DIALOG



68 X 36 X 195



AVAILABLE WORKTOPS:
MDF, PLYWOOD, GLASS



Z-LINE / DD Z-LINE CONFERENCE TABLE

COMPILATION OF Z-LINE/DD Z-LINE DESKS AND CORNERS





PISA

SHELF MADE OF MDF BOARD PAINTED IN HIGH GLOSS
BRACKETS MADE OF CHROME-PLATED METAL
SOLID AND STRONG CONSTRUCTION



DIMENSIONS (W X D X H cm):
120 x 40 x 165

DESK TOP MADE OF TEMPERED GLASS WITH A 10 MM THICKNESS
TABLE BASE MADE OF LACQUERED METAL
CABINET MADE OF MDF BOARD PAINTED IN HIGH GLOSS
DRAWERS EQUIPPED WITH SLIDES WITH SILENT CLOSING MECHANISM

MARIN



DIMENSIONS (W X D X H CM):
TABLETOP: 120 X 60 X 76
CUPBOARD: 120 X 42 X 61



TIVANO

TABLE TOP AND CABINET MADE OF MDF HIGH GLOSS VARNISHED BOARD
STABLE, VERY STRONG CONSTRUCTION
DRAWERS EQUIPPED WITH SLIDES WITH SILENT CLOSING MECHANISM



DIMENSIONS (W X D X H cm):
TABLE TOP: 120 X 60 X 76
CUPBOARD: 120 X 42 X 61

DESK TOP MADE OF HIGH GLOSS LACQUERED MDF BOARD WITH BUILT-IN DRAWER
DESK LEGS MADE OF CHROME-PLATED STEEL
SOLID STABLE AND VERY STRONG CONSTRUCTION
MAXIMUM TABLE TOP LOAD 120 KG, POINT LOAD 40 KG

ZEFIR



DIMENSIONS (W X D X H cm):
120 x 55 x 76



SECA

DESK TOP MADE OF TEMPERED GLASS WITH 10 MM THICKNESS
TABLE TOP BASE AND SUPPORTS ARE MADE OF BRUSHED STEEL

CABINET MADE OF MDF BOARD PAINTED IN HIGH GLOSS
DRAWERS EQUIPPED WITH BALL-BEARING SLIDES



*POSSIBILITY OF LEFT / RIGHT CABINET CONFIGURATION

DIMENSIONS (W X D X H CM):
TABLE TOP: 120 X 55 X 76
CUPBOARD: 38 X 55 X 62



DESK MADE OF HIGH GLOSS VARNISHED MDF BOARD
SOLID STABLE AND VERY STRONG CONSTRUCTION
MAXIMUM TABLE TOP LOAD 120 KG, POINT LOAD 40 KG

B I S E



DIMENSIONS (W X D X H CM):
120 x 60 x 76



BORA

DESK TOP MADE OF WHITE COLOURED HIGH GLOSS
LACQUERED MDF BOARD
DESK LEGS MADE OF CHROME-PLATED STEEL

SOLID STABLE AND VERY STRONG CONSTRUCTION
MAXIMUM TABLE TOP LOAD 120 KG, POINT LOAD 40 KG



DIMENSIONS (W X D X H CM):
120 x 60 x 76

DESK TOP MADE OF HIGH GLOSS LACQUERED MDF BOARD
DESK LEGS MADE OF CHROME-PLATED STEEL
SOLID STABLE AND VERY STRONG CONSTRUCTION
MAXIMUM TABLE TOP LOAD 120 KG, POINT LOAD 40 KG

SOLANO



DIMENSIONS (W X D X H CM):
120 x 60 x 76



AMY

TABLE TOP MADE OF MDF BOARD LACQUERED IN MATT COLOUR
EXTENSION MADE OF MDF BOARD FINISHED WITH VENEER

DESK LEGS MADE OF POWDER-COATED METAL
SOLID STABLE AND VERY STRONG CONSTRUCTION



DIMENSIONS (W X D X H CM):
120 X 60 X 80,5

TABLE TOP MADE OF MDF BOARD LACQUERED IN MATT COLOUR
DRAWER FRONT MADE OF MDF BOARD FINISHED WITH VENEER

DESK LEGS MADE OF POWDER-COATED METAL
SOLID STABLE AND VERY STRONG CONSTRUCTION

C L E O



DIMENSIONS (W X D X H CM):
110 X 55 X 76



DELLA

TABLETOP MADE OF LACQUERED BOARD IN MATT COLOUR
DRAWER FRONTS MADE OF BOARD FINISHED WITH OAK-COLOURED VENEER

DESK LEGS MADE OF POWDER-COATED METAL
SOLID STABLE AND VERY STRONG CONSTRUCTION



TABLE TOP MADE OF MDF BOARD LACQUERED IN MATT COLOUR
DRAWER FRONTS MADE OF SOLID WOOD

DESK LEGS MADE OF POWDER-COATED METAL
SOLID STABLE AND VERY STRONG CONSTRUCTION

DORIS



DIMENSIONS (W X D X H CM):
110 X 55 X 76



EDNA

DESK TOP MADE OF LACQUERED MDF BOARD
IN A STONE IMITATION COLOUR
THREE BUILT-IN DRAWERS

DESK LEGS MADE OF BRUSHED NICKEL
SOLID STABLE AND VERY STRONG CONSTRUCTION



TABLE TOP MADE OF MDF BOARD LACQUERED IN MATT COLOUR
DESK LEGS MADE OF POWDER-COATED METAL
SOLID STABLE AND VERY STRONG CONSTRUCTION

GRACE



DIMENSIONS (W X D X H CM):
110 X 50 X 86



CONTAINER

RP-01 / RP-04

BODY WITH LACQUERED METAL
LOCKABLE DRAWERS
WHEELS WITH BRAKES

REPOH SILENT GUIDE RAILS
INSIDE AN ADDITIONAL ORGANIZER
FULL DRAWER PULL-OUT



BODY MADE OF LACQUERED METAL
WHEELS WITH BRAKES
INSIDE AN ADDITIONAL ORGANIZER

LOCKABLE DRAWERS
RECON SILENT GUIDE RAILS
FULL DRAWER PULL-OUT

CONTAINER

RPH-01 / RPH-02



CONTAINER 324/325

BODY MADE OF LACQUERED METAL
WHEELS WITH BRAKES
INSIDE AN ADDITIONAL ORGANIZER

LOCKABLE DRAWERS
AVAILABLE WITH THREE OR FOUR DRAWERS
IN 324 VERSION THE CONTAINER HAS A DRAWER FOR FILES



BODY MADE OF LACQUERED METAL
WHEELS WITH BRAKES

INSIDE AN ADDITIONAL ORGANIZER
LOCKABLE DRAWERS

CONTAINER 4 2 4



CONTAINER JS6W-010

BODY MADE OF HIGH GLOSS LACQUERED MDF BOARD
CONTAINER WITH WHEELS







TABLES AND CHAIRS

M U Z E

UNIVERSAL, PRACTICAL CHAIR FOR INDOOR OR OUTDOOR USE
STABLE CONSTRUCTION
LOW WEIGHT: 3,5 KG
STACKING POSSIBILITY

RESISTANCE TO WEATHER CONDITIONS
HOLE IN THE SEAT AND SUITABLE
CONTOURED PROVIDE THE WATER OUTFLOW



AVAILABLE IN 5 DIFFERENT POLYPROPYLENE COLOURS



SEAT UPHOLSTERED WITH PLEASANT TOUCH FABRIC
NATURAL WOOD LEGS

LINE



AVAILABLE UPHOLSTERY:
MZ FABRIC (3 COLOURS)



CITY

SEAT UPHOLSTERED WITH PLEASANT TOUCH FABRIC
CHROME-PLATED METAL BASE



SWIVEL SEAT, UPHOLSTERED WITH ECO-LEATHER
CHROME-PLATED METAL BASE

STILO



AVAILABLE UPHOLSTERY:
ECO-LEATHER (5 COLOURS)



SULTAN

FABRIC UPHOLSTERY
CHROME-PLATED LEGS
REMOVABLE SEAT PILLOW (EASY TO WASH)



ECO-LEATHER UPHOLSTERY
METAL LEGS UPHOLSTERED WITH ECO-LEATHER

SETINA



AVAILABLE UPHOLSTERY:
ECO-LEATHER OF PU (PU-0, PU-3, PU-4)



EASY

BACKREST AND SEAT MADE OF STRONG PP MATERIAL
BASE MADE OF LACQUERED METAL OR WOOD



BACKREST AND SEAT MADE OF STRONG PP MATERIAL UPHOLSTERED WITH FABRIC
BASE MADE OF LACQUERED METAL OR WOOD

EASY R



AVAILABLE UPHOLSTERY:
FABRIC LF (6 COLOURS)



DESIGN

METAL CONSTRUCTION COVERED WITH FABRIC OR ECO LEATHER
LOW WEIGHT
STACKING POSSIBILITY



AVAILABLE UPHOLSTERY:
ECO LEATHER PU DESIGN (9 COLOURS)
PVC FABRIC (5 COLOURS)



SEAT MADE OF PP MATERIAL
CHROME-PLATED METAL LEGS
STACKING POSSIBILITY

A R E A



3 COLOURS AVAILABLE (WHITE, GREY, BLACK)



LUMI

SEAT UPHOLSTERED WITH PLEASANT TO TOUCH FABRIC
CHROME-PLATED METAL LEGS



SEAT MADE OF PP MATERIAL
LEGS MADE OF BEECHWOOD

O P E N



3 COLOURS AVAILABLE (WHITE, GREY, BLACK)



SOFT

SEAT UPHOLSTERED WITH PLEASANT TO TOUCH FABRIC
LEGS MADE OF BEECHWOOD



SWIVEL SEAT UPHOLSTERED WITH ECO LEATHER
BASE MADE OF CHROME-PLATED METAL

TALIA



AVAILABLE UPHOLSTERY:
ECO LEATHER PU (WHITE, BLACK)



HELENA

FOLDABLE TABLE
TABLE TOP MADE OF LACQUERED MDF
NATURAL WOOD LEGS



FOLDABLE TABLE
8MM GLASS TABLE TOP COVERED WITH 3MM CERAMIC COATING
METAL TABLE FRAME POWDER-COATED

LUNA



DIMENSIONS (W X D X H CM):
120-180 x 85 x 76



TEXAS RDG

TOP MADE OF TEMPERED GLASS WITH 10MM THICKNESS AND A 120 CM DIAMETER
BASE MADE OF METAL PROFILE, POWDER-COATED



TOP MADE OF TEMPERED GLASS WITH 10MM THICKNESS AND DIMENSIONS: 160 X 90 CM
BASE MADE OF METAL PROFILE, POWDER-COATED

TEXAS PMG



DIMENSIONS (W X D X H CM):
PMG: 160 x 90 x 75



MONTANA

FOLDABLE TABLE
GRAY COLOUR 10MM GLASS TOP
SOLID WOOD CONSTRUCTION



FOLDABLE TABLE
TOP MADE OF MDF BOARD COVERED WITH WOODEN VENEER
SOLID WOOD CONSTRUCTION

MALMO



DIMENSIONS (W X D X H CM):
160-200 X 90 X 76





HOKERS AND BAR TABLES

DUKE

ECO-LEATHER UPHOLSTERED SEAT
BASE MADE OF LACQUERED METAL



SWIVEL SEAT, UPHOLSTERED WITH ECO-LEATHER
CHROME-PLATED METAL BASE
SEAT HEIGHT ADJUSTMENT

CARINO



AVAILABLE UPHOLSTERY:
ECO LEATHER PU (5 COLOURS)

CLUB / SPOONY

SWIVEL SEAT MADE OF LACQUERED MATERIAL
CHROME-PLATED METAL BASE
SEAT HEIGHT ADJUSTMENT



TABLE TOP OF LACQUERED MATERIAL
TWO TABLE HEIGHTS AVAILABLE
BASE MADE OF CHROME-PLATED METAL

ROUND / BISTRO



AVAILABLE IN 6 COLOURS OF ABS MATERIAL
DIMENSIONS (W X D X H CM):
ROUND: 60 X 111
BISTRO: 60 X 72





DYNAMIQ

GAMING CHAIRS AND DESKS

DYNAMIQ V3

SEAT AND BACKREST UPHOLSTERED WITH ECO-LEATHER AND FABRIC
MULTIBLOCK SWING MECHANISM
INDEPENDENT ADJUSTMENT OF BACKREST TILT RELATIVE TO THE SEAT

ADDITIONAL LUMBAR AND CERVICAL SUPPORT LEGS
BASE MADE OF LACQUERED METAL



ADJUSTMENTS:

- SEAT HEIGHT
- 4D ARMRESTS



SEAT AND BACKREST UPHOLSTERED WITH ECO-LEATHER AND FABRIC
TILT SWING MECHANISM
INDEPENDENT ADJUSTMENT OF BACKREST TILT RELATIVE TO THE SEAT

ADDITIONAL LUMBAR AND CEVICAL SUPPORT LEGS
BASE MADE OF LACQUERED METAL

DYNAMIQ V5

ADJUSTMENTS:

- SEAT HEIGHT
- HEIGHT OF ARMRESTS



AVAILABLE UPHOLSTERY:
ECO-LEATHER PU (2 COLOURS)



DYNAMIQ V7

SEAT AND BACKREST UPHOLSTERED WITH ECO-LEATHER AND MEMBRANE
ARMRESTS WITH SOFT PADS

TILT SWING MECHANISM
HIGH QUALITY BASE

ADJUSTMENTS:

- SEAT HEIGHT



AVAILABLE UPHOLSTERY:
ECO-LEATHER PU (2 COLOURS)



ARMCHAIR EQUIPPED WITH BLUETOOTH SPEAKER AND LED LIGHTING
SEAT AND BACKREST UPHOLSTERED WITH ECO-LEATHER

INDEPENDENT ADJUSTMENT OF BACKREST TILT RELATIVE TO THE SEAT
BASE MADE OF LACQUERED PLASTIC

DYNAMIQ V9

ADJUSTMENTS:

- SEAT HEIGHT
- HEIGHT OF HEADREST
- 4D ARMRESTS



AVAILABLE UPHOLSTERY:
ECO-LEATHER PU



DYNAMIQ V11

SEAT AND BACKREST UPHOLSTERED WITH ECO-LEATHER AND MESH
HIGH QUALITY BASE
ARMRESTS WITH SOFT PADS

ADJUSTMENTS:
• SEAT HEIGHT
• HEIGHT OF ARMRESTS



SEAT AND HEADREST UPHOLSTERED WITH ECO-LEATHER
BACKREST UPHOLSTERED WITH MESH
HIGH QUALITY BASE

ADJUSTMENTS:
• SEAT HEIGHT

DYNAMIQ V13



AVAILABLE UPHOLSTERY:
SEAT AND HEADREST: ECO-LEATHER PU
BACKREST: MESH



DYNAMIQ V2

TABLETOP MADE OF MDF BOARD
DESK LEGS MADE OF POWDER-COATED METAL



TABLETOP MADE OF MDF BOARD
DESK LEGS MADE OF POWDER-COATED METAL
DESK LEGS EQUIPPED WITH LEDS

DYNAMIQ V4



DIMENSIONS (W X D X H CM):
120 X 60 X 72



DYNAMIQ V6

TABLETOP MADE OF MDF BOARD
DESK LEGS MADE OF POWDER-COATED METAL
DESK LEGS EQUIPPED WITH LEDS



TABLETOP MADE OF MDF BOARD
TABLETOP EQUIPPED WITH LEDS

DESK LEGS MADE OF POWDER-COATED METAL
DESK LEGS EQUIPPED WITH LEDS

DYNAMIQ V8



DIMENSIONS (W X D X H CM):
120 X 60 X 71,5





ACCESSORIES

WHEELS / FEET / BASES / ARMRESTS

WHEELS:



RUBBER-COATED CPU-60 (CT-09)



RUBBER-COATED CPU-50 (CT-04)



NYLON CPU-60 (CT-07)



NYLON CPU-60 (CT-11)

BASES:



CHROME-PLATED METAL (CH-05)



ALUMINIUM (0009)



NYLON (PA-N340)

FEET:



CHROME-PLATED (CT-01)



NYLON (CT-06)

ARMRESTS:



ADJUSTABLE (AD-18)



Z - LINE / DD Z-LINE

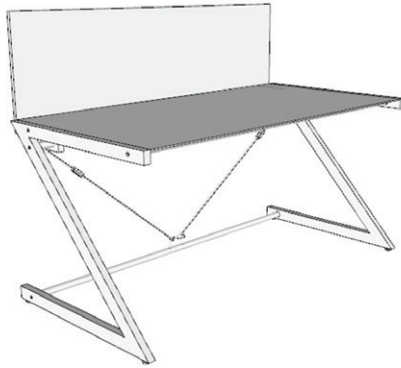

DESK WALL FROM Z-LINE/DD Z-LINE SERIES

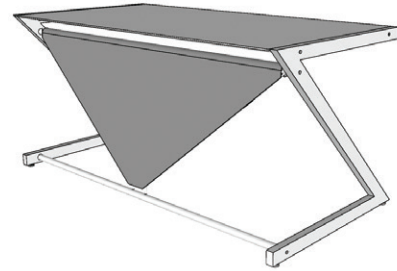

BLENDE FROM Z-LINE / DD Z-LINE SERIES

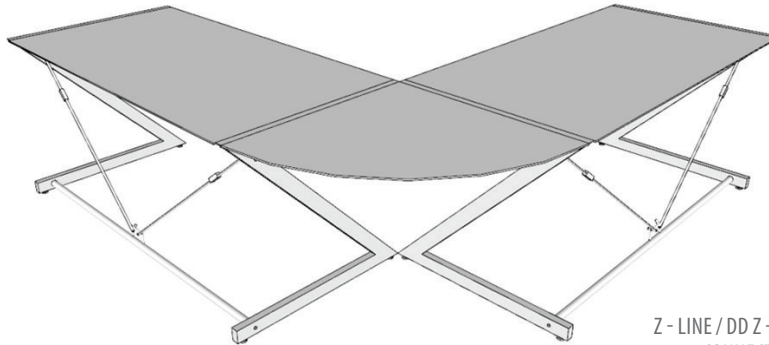

Z - LINE / DD Z - LINE SERIES
CONNECTING CORNER





PATTERNS OF FINISHES

CONSTRUCTION Z-LINE / DD Z-LINE

TYPES AND COLOURS OF TABLETOPS Z-LINE / DD Z-LINE

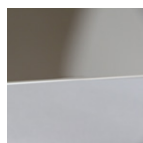

CHROM

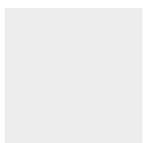

WHITE LACQUER



BLACK LACQUER



WHITE GLASS



BLACK GLASS



LACQUERED WHITE
MDF BOARD



LACQUERED BLACK
MDF BOARD



OAK VENEER MDF
BOARD



OAK VENEER
PLYWOOD

SM FABRIC



SM 2327

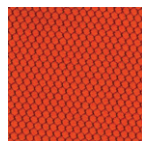

SM2302

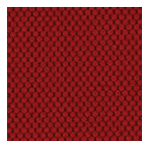

SM2307

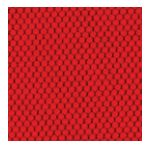

SM2312



SM2315

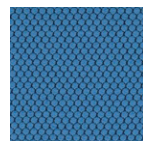

SM2320

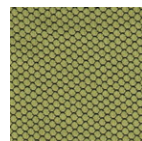

SM2339

PVC FABRIC

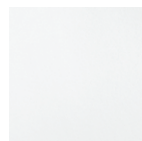

PVC0

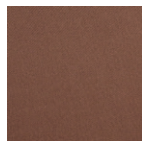

PVC3



PVC4



PVC8



PVC11



FABRIC BL

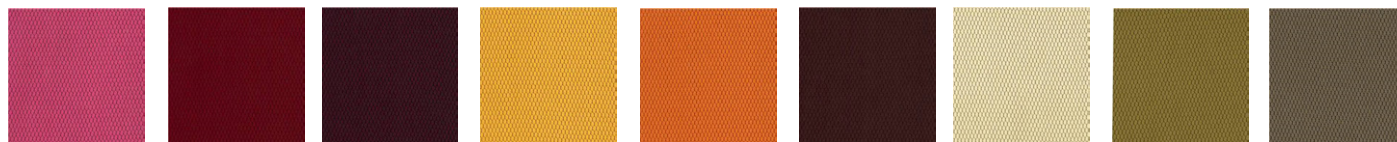

BL401

BL402

BL403

BL404

BL405

BL406

BL407

BL408

BL409



BL410

BL411

BL412

BL413

BL414

BL415

BL416

BL417

BL418

FABRIC BLH

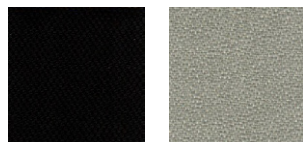

BLH4

BLH8

FABRIC LF



LF11

LF12

LF16

LF19

LF25

LF26



FABRIC MT



MT1

MT2

MT4

MT8

MT9

FABRIC MZ

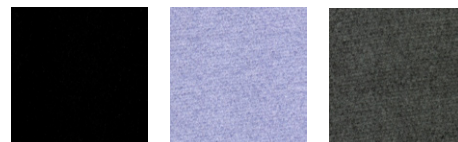

MZ4

MZ7

MZ8

PS MEMBRANE FABRIC

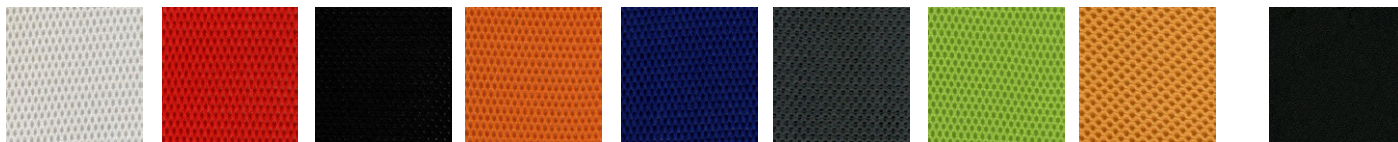

PS0

PS2

PS4

PS5

PS7

PS8

PS9

PS10

NL4

NYLON NL

MESH M NET

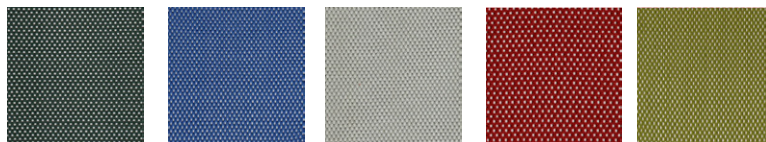

MESH32

MESH33

MESH34

MESH35

MESH37



MESH C NET

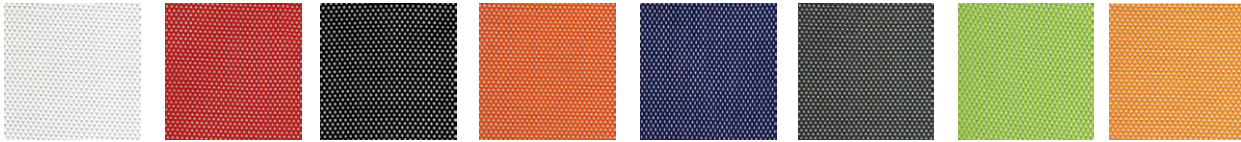

MESH0

MESH2

MESH4

MESH5

MESH7

MESH8

MESH9

MESH10

NWH NET

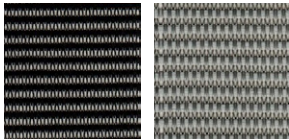

NWH4

NWH8

NWM NET

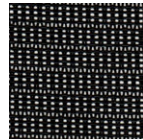

NWM4

NW NET

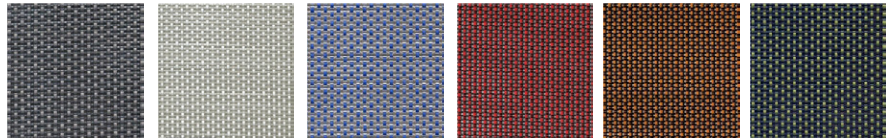

NW41

NW42

NW43

NW44

NW45

NW46

ABS MATERIAL



ABS0

ABS1

ABS2

ABS3

ABS4

ABS6

ELASTOMER TPE

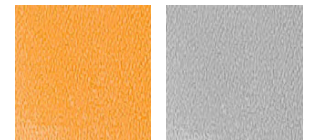

TPE12

TPE8 147

MUZE MATERIAL

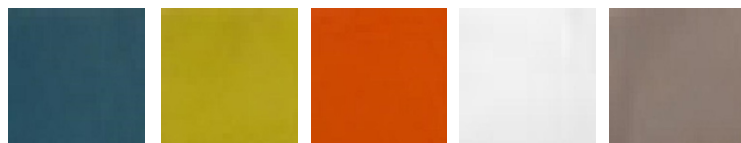

94FN

94HN

94JN

94PN

94TN

HL NATURAL LEATHER



HL4

HL3

HL1

HL0

PU DESIGN ECO LEATHER



PU0

PU3

PU4

PU14

PU21

PU23

PU26

PU79

PU ECO LEATHER



PU0

PU1

PU2

PU3

PU4

PU9



NEWS



NEWS



*UNIQUE SP. Z O.O. Z O.O. RESERVES THE RIGHT TO INTRODUCE CHANGES IN THE
OFFER AND STRUCTURAL CHANGES IN THE PRODUCTS.
WITHOUT CHANGING THEIR GENERAL CHARACTER.*



U N I Q U E
D E S I G N F O R P E O P L E

UNIQUE SP. Z O. O.

STOJADŁA

UL. KOŁBIELSKA 27

05-300 MIŃSK MAZOWIECKI

NIP: 822-235-29-62

E-MAIL: INFO@UNIQUE-MEBLE.PL

TEL./FAX (+48) 25 758 78 11

DISTRIBUTOR



UNIQUE
DESIGN FOR PEOPLE

TEL. +48 25 758 70 11
INFO@UNIQUE-MEBLE.PL

WWW.UNIQUE-MEBLE.PL